

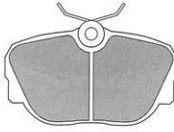









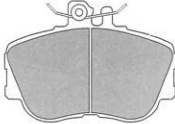
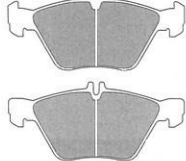

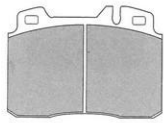
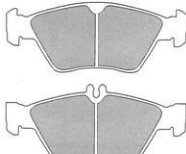
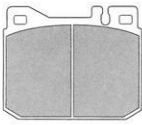

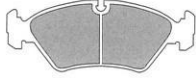

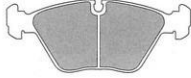



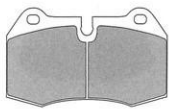

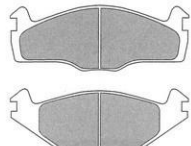
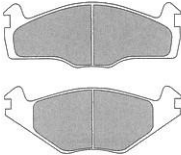
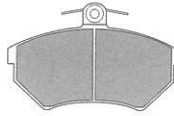
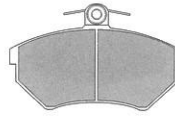

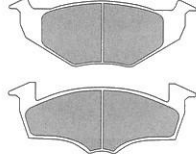

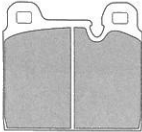
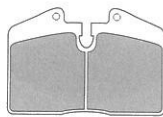
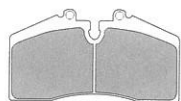
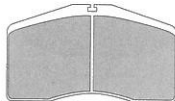
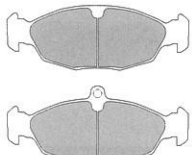

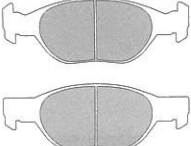
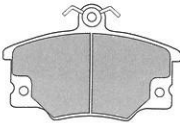
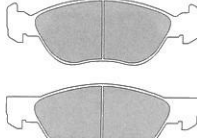
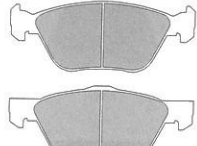

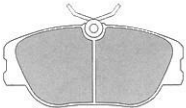
GLADimp Brake Pad ILLUSTRATION

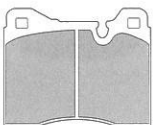
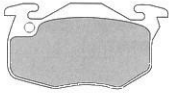
<p>F#001</p>  <p>W116.2×H57.7</p>	<p>F#002</p>  <p>W95×H52</p>	<p>F#003</p>  <p>W110×H59.6</p>	<p>F#004</p>  <p>W110×H74.5</p>
<p>F#005</p>  <p>W156.3×H63.7/H69.4</p>	<p>F#007</p>  <p>W194.2×H73.5</p>	<p>F#008</p>  <p>W99.8×H73.5×T15.5</p>	<p>F#009</p>  <p>W151×H60×H66</p>
<p>F#010</p>  <p>W89.8×H73.8</p>	<p>F#011</p> 	<p>F#012</p>  <p>W98×H84.5</p>	<p>F#020</p>  <p>W158.5×H58</p>
<p>F#021</p>  <p>W151×H57</p>	<p>F#022</p>  <p>W156×H63.5</p>	<p>F#023</p>  <p>W151×H57</p>	<p>F#024</p>  <p>W156×H63.5</p>
<p>F#025</p>  <p>W156×H73.2</p>	<p>F#026</p>  <p>W120×H73.7</p>	<p>F#027</p>  <p>W194.2×H73.5</p>	<p>F#032</p>  <p>W137.6×H51.3×T19</p>

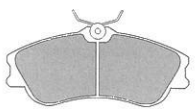

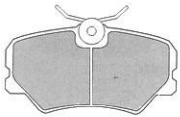
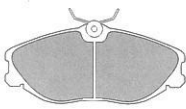
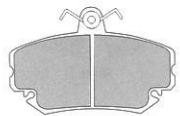



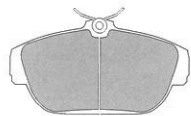
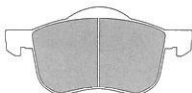
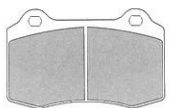



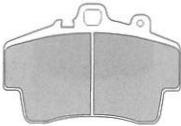

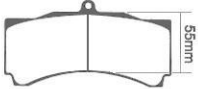

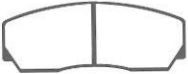

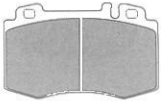
GLADimp Brake Pad ILLUSTRATION

<p>F#033</p>  <p>W137.6×H51.3×T15</p>	<p>F#034</p>  <p>W119×H69.5×T16</p>	<p>F#035</p>  <p>W119×H69.5×T19</p>	<p>F#036</p>
<p>F#037</p>  <p>W156.3×H74</p>	<p>F#038</p>  <p>W146×H55.5</p>	<p>F#039</p>  <p>W141.8×H51.2/H50.6</p>	<p>F#042</p>  <p>W156.3×H74</p>
<p>F#044</p>  <p>W76.6×H70</p>	<p>F#045</p>  <p>W97.8×H65.5</p>	<p>F#046</p>  <p>W131.8×H71</p>	<p>F#047</p>  <p>W131.8×H71</p>
<p>F#048</p>	<p>F#049</p>	<p>F#054</p>  <p>W141.3×H48.3/W140×H58.2</p>	<p>F#055</p>  <p>W156.3×H52.4</p>
<p>F#057</p>  <p>W151.3×H52</p>	<p>F#058</p>  <p>W104×H67</p>	<p>F#059</p>  <p>W156.3×H52</p>	<p>F#060</p>  <p>W156.3×H59/H61.8</p>

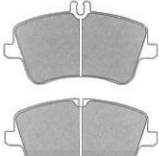

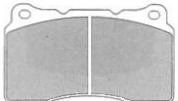
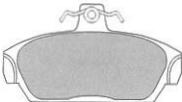







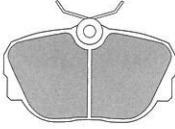
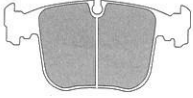

GLADimp Brake Pad ILLUSTRATION

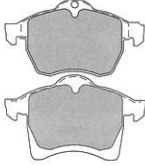
<p>F#061</p>  <p>W130×H58.6</p>	<p>F#063</p>  <p>W109.8×H69.2×T17.5</p>	<p>F#069</p>  <p>W114.8×H55.5</p>	<p>F#070</p>
<p>F#071</p>  <p>W90×H70.5</p>	<p>F#072</p>	<p>F#073</p>	<p>F#075</p>  <p>W105×H54</p>
<p>F#076</p>  <p>W140×H47.5</p>	<p>F#077</p>  <p>W130×H56.2</p>	<p>F#078</p>  <p>W131×H47.5</p>	<p>F#079</p>  <p>W94.8×H49</p>
<p>F#080</p>  <p>W130×H56.5</p>	<p>F#081</p>  <p>W100×H64.5</p>	<p>F#084</p>  <p>W70.2×H58.4</p>	<p>F#085</p>  <p>W74.2×H64</p>
<p>F#086</p>  <p>W156×H58.3</p>	<p>F#088</p>  <p>W129×H65</p>	<p>F#089</p>  <p>W156.3×H68.5</p>	<p>F#090</p>  <p>W109.8×H69.2×T15</p>

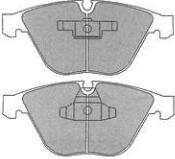
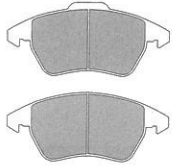

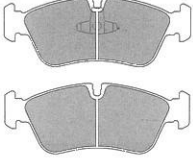
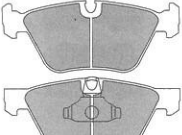
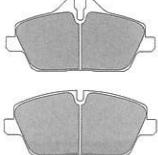
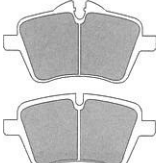
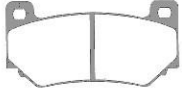

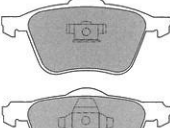







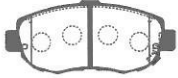
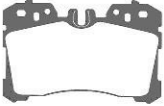

GLADimp Brake Pad ILLUSTRATION

<p>F#092</p>  <p>W131.6×H66.8×T18</p>	<p>F#093</p>  <p>W114×H78</p>	<p>F#094</p>  <p>W141×H59</p>	<p>F#095</p>  <p>W152×H79.5×T18</p>
<p>F#096</p>  <p>W152×H76.5×T18</p>	<p>F#097</p>  <p>W152×H76.5×T18</p>	<p>F#099</p>  <p>W132.3×H55.7×T16</p>	<p>F#100</p>  <p>W139.7×H70×T18</p>
<p>F#101</p>  <p>W119.6×H71.7</p>	<p>F#103</p>  <p>W140×H88.5</p>	<p>F#104</p>  <p>W79.5×H56×T18</p>	<p>F#105</p> 
<p>F#111</p>  <p>W137×H57.5</p>	<p>F#112</p>  <p>W131×H70/H62</p>	<p>F#113</p>  <p>W136.8×H51</p>	<p>F#116</p>  <p>W131.8×H77.2×T15</p>
<p>F#117</p>  <p>W115×H60</p>	<p>F#119</p>  <p>W131×H52.5</p>	<p>F#122</p>  <p>W137×H67.8</p>	<p>F#124</p>  <p>W97.5×H78.5</p>

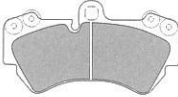
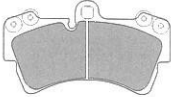

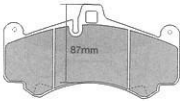
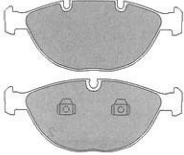

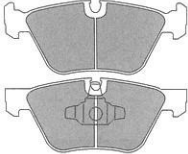
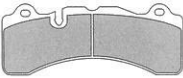





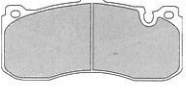
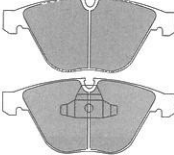

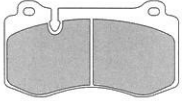

GLADimp Brake Pad ILLUSTRATION

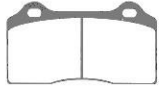
<p>F#125</p>  <p>W134×H64.5</p>	<p>F#127</p>  <p>W156.3×H65</p>	<p>F#128</p>  <p>W95×H52</p>	<p>F#129</p>  <p>W156.3×H71.5</p>
<p>F#130</p>  <p>W190×H101</p>	<p>F#133</p>  <p>W156.3×H74</p>	<p>F#134</p>  <p>W156.3×H52.4</p>	<p>F#135</p>  <p>W109×H47.5</p>
<p>F#136</p>  <p>W155×H68</p>	<p>F#138</p>  <p>W156.4×H71.4/H66</p>	<p>F#143</p>  <p>W131.8×H62×T16/T25</p>	<p>F#145</p>  <p>W150×W149.5×H57</p>
<p>F#147</p>  <p>W156×H63.5×T20</p>	<p>F#148</p>  <p>W131.3×H65.5/H53</p>	<p>F#151</p>  <p>W131.5×H71.5/H63.8</p>	<p>F#154</p>  <p>W113.5×H58.5×T16</p>
<p>F#156</p>  <p>W76.2×H65</p>	<p>F#158</p> 	<p>F#159</p>  <p>W156×H70</p>	<p>F#160</p>  <p>W164.6×H82.5</p>

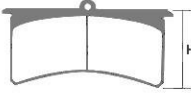
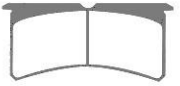
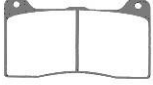
GLADimp Brake Pad ILLUSTRATION

<p>F#161</p>  <p>W130×H80.6×T16.5</p>	<p>F#162</p>  <p>W154.8</p>	<p>F#163</p>  <p>W118.5</p>	<p>F#164</p>  <p>W144</p>
<p>F#165</p>  <p>W133.6</p>	<p>F#170</p>  <p>W61.5×T17</p>	<p>F#171</p>  <p>W61.5×T13.5</p>	<p>F#173</p>  <p>W113.5×H45.4×T16</p>
<p>F#174</p>  <p>W113.5×H52.1×T16</p>	<p>F#175</p>  <p>W113.5×H52.1×T16</p>	<p>F#176</p>  <p>W190×H99</p>	<p>F#178</p>  <p>W190×H106</p>
<p>F#179</p>  <p>W121×H90.3×T16</p>	<p>F#180</p>  <p>W190×H101×T18</p>	<p>F#182</p>  <p>W156×H70</p>	<p>F#184</p>  <p>W96.5×H74.1</p>
<p>F#185</p>  <p>W163.2×H65.5×T14</p>	<p>F#187</p>  <p>W156×H63.5×T20</p>	<p>F#188</p>  <p>W189.6×H73.5×T17</p>	<p>F#189</p>  <p>W189.6×H87.3×T17</p>

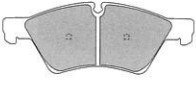
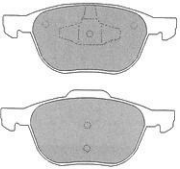
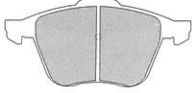





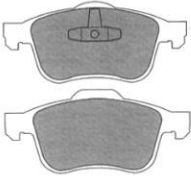
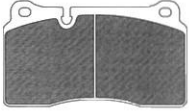





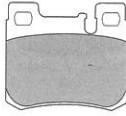
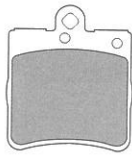
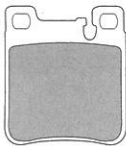
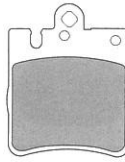

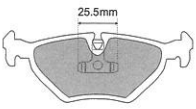
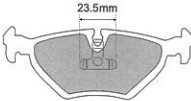
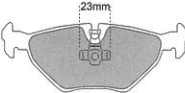
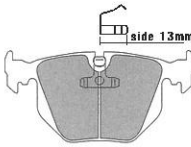
GLADimp Brake Pad ILLUSTRATION

<p>F#190</p>  <p>W164×H73.7×T16.5</p>	<p>F#192</p>  <p>W155×H68</p>	<p>F#193</p>  <p>W130×H63</p>	<p>F#194</p>  <p>W141.6×H75.8×T17.5</p>
<p>F#195</p>  <p>W189.6×H92.7×T17</p>	<p>F#196</p>  <p>W189.6×H97.7×T17</p>	<p>F#197</p>  <p>W101.7×H79.3×T16.5</p>	<p>F#200</p>  <p>W109.8×H61.6×T15</p>
<p>F#201</p>  <p>W132×H62.6×T15</p>	<p>F#202</p>  <p>W100×H65.3×T12.5</p>	<p>F#203</p>  <p>W120.4×H61.7×T20</p>	<p>F#204</p>  <p>W120.4×H61.7×T20</p>
<p>F#205</p>  <p>W100.6×H56×T15</p>	<p>F#206</p>  <p>W149×H81.7×T16.5</p>	<p>F#207</p>  <p>W149×H85.7×T16.5</p>	<p>F#208</p>  <p>W83.9×H56×T15</p>
<p>F#209</p>  <p>W193.1/W194.3×H70×T21</p>	<p>F#211</p>  <p>W155.3×H60.5/W194.3×H65.3</p>	<p>F#212</p>  <p>W156.3×H71.3/W155.2×H72.3</p>	<p>F#213</p>  <p>W130×H77×T17</p>

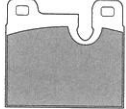











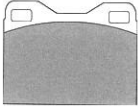
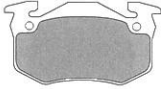

GLADimp Brake Pad ILLUSTRATION

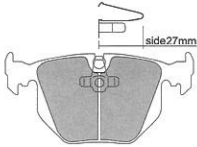
F#214	F#216	F#220	F#221
 <p>W130×H72.8</p>			 <p>W131.6×H77.3</p>
F#223	F#224	F#225	F#226

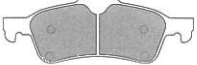

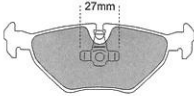







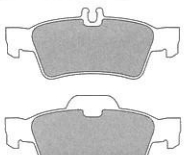

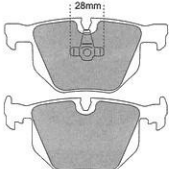
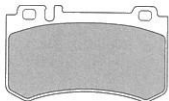

GLADimp Brake Pad ILLUSTRATION

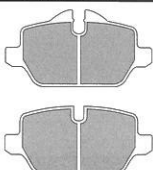
<p>R#013</p>  <p>W61.8×H55</p>	<p>R#014</p>  <p>W61.8×H58.5</p>	<p>R#015</p>  <p>W61.8×H55</p>	<p>R#016</p>  <p>W63.8×H72.8</p>
<p>R#017</p>  <p>W61.8×H69.5</p>	<p>R#018</p>  <p>W63.8×H78</p>	<p>R#019</p>  <p>W61.5×H56.5</p>	<p>R#028</p>  <p>W123×H44.9</p>
<p>R#029</p>  <p>W123×H44.9</p>	<p>R#030</p>  <p>W123×H44</p>	<p>R#031</p>  <p>W123×H59.5</p>	<p>R#040</p>  <p>W87×H53×T14.7</p>
<p>R#041</p>  <p>W87×H53×T16</p>	<p>R#043</p>  <p>W87×H66.8</p>	<p>R#050</p>  <p>W61.5×H56.5×T15</p>	<p>R#051</p>  <p>W63.8×H65×T15</p>
<p>R#052</p>  <p>W112.3×H73.2</p>	<p>R#053</p>  <p>W114.2×H73×T15.5</p>	<p>R#056</p>  <p>W61.7×H57.5</p>	<p>R#064</p>  <p>W87×H44.5</p>

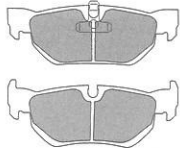

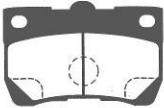

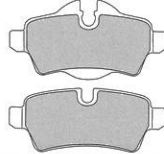

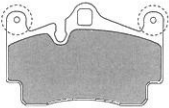
GLADimp Brake Pad ILLUSTRATION

<p>R#065</p>  <p>W95.8×H44</p>	<p>R#066</p>  <p>W89.8×H50</p>	<p>R#067</p>  <p>W87×H66.8</p>	<p>R#068</p>
<p>R#074</p>  <p>W77×H59×T15</p>	<p>R#082</p>  <p>W105×H55</p>	<p>R#083</p>  <p>W86.8×H53</p>	<p>R#087</p>  <p>W61.5×H56.5</p>
<p>R#091</p>  <p>W122.5×H54</p>	<p>R#098</p>  <p>W123×H59.5</p>	<p>R#102</p>  <p>W121.2×H86.5</p>	<p>R#106</p>  <p>W122×H43</p>
<p>R#107</p>  <p>W90×H53.5</p>	<p>R#108</p>  <p>W87×H44.5</p>	<p>R#109</p>  <p>W123×H44</p>	<p>R#110</p>  <p>W125×H36.5</p>
<p>R#114</p>  <p>W63.8×H63.2</p>	<p>R#115</p>  <p>W62×H61.2</p>	<p>R#118</p>	<p>R#120</p>  <p>W76.8×H65.5</p>

GLADimp Brake Pad ILLUSTRATION

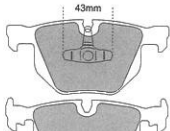
<p>R#121</p>  <p>W71×H68.8</p>	<p>R#123</p>  <p>W140.5×H57.4/H59.7</p>	<p>R#126</p>  <p>W105×H52.8</p>	<p>R#132</p>  <p>W63.8×H57.8</p>
<p>R#137</p>  <p>W136.8×H67.7</p>	<p>R#139</p>  <p>W63.8×H57.8</p>	<p>R#141</p>  <p>W121.8×H57.8</p>	<p>R#142</p>  <p>W111.6×H64</p>
<p>R#144</p>  <p>W104.8×H42.5</p>	<p>R#146</p>  <p>W95.5×H50.7/H45</p>	<p>R#149</p>  <p>W95.6×H41.3</p>	<p>R#150</p>  <p>W105×H56</p>
<p>R#152</p>  <p>W123×H43/H48.5</p>	<p>R#157</p>  <p>W126×H58.5</p>	<p>R#166</p>  <p>W87.9</p>	<p>R#167</p>  <p>W57</p>
<p>R#168</p>  <p>W75</p>	<p>R#169</p>  <p>W95.3×H39.2/H57.8×T17.3</p>	<p>R#172</p>  <p>W111.6×H64</p>	<p>R#177</p>  <p>W117×H73×T16.7</p>

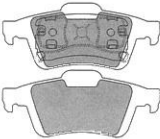
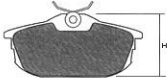
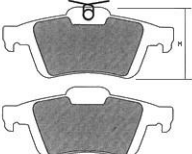
GLADimp Brake Pad ILLUSTRATION

R#181	R#183	R#186	R#191
 <p data-bbox="128 401 241 420">W127.8×H75.3</p>	 <p data-bbox="383 405 467 423">W116×H59</p>	 <p data-bbox="614 408 710 426">W122×H59.5</p>	 <p data-bbox="841 408 958 426">W84×H87×T15</p>
R#199	R#210	R#215	R#217
 <p data-bbox="128 654 241 672">W123.2×H51.9</p>	 <p data-bbox="383 654 467 672">W87×H47</p>	 <p data-bbox="614 654 710 672">W123.2×H48</p>	 <p data-bbox="831 654 969 672">W116.7×H50×T18</p>
R#218	R#219	R#222	R#227
R#228			